

ELECTRONIC COMPONENTS

PRODUCTS GUIDE 2020

Connectors

Switches

Touch Sensors

Microphones

Receiver Units

Micro Speaker Units

Earphone-Microphones

Headphones

Wireless Connectivity Products

Remote Control Units

Circuit Protectors







DC Solenoids

Chargers

コネクタ Connectors	HDMIコネクタ / HDMI Connectors	2
	USBコネクタ / USB Connectors	3
	DisplayPort™ コネクタ / DisplayPort™ Connectors	4
	スロットインタイプコネクタ / Slot-in type Connectors	4
	FAKRAコネクタ / FAKRA Connectors	5
	小型同軸コネクタ / Miniature Coaxial Connectors	5
	車載カメラ用コネクタ / Connectors for in-vehicle Camera	5
	高速信号伝送コネクタ(4ピン) / High Speed Data Transfer Connectors (4Pin)	6
	角形マイクロミニチュアコネクタ / Micro-Miniature Rectangular Connectors	6
	角形コネクタ / Rectangular Connectors	7
	丸形ミニチュアコネクタ / Miniature Circular Connectors	7
	電源用コネクタ / Power Supply Connectors	8
	ACインレット / AC Inlets	8
	小形ジャック / Miniature Jacks	9
	DC電源ジャック / DC Power Jacks	9
太陽光発電システム用コネクタ / PV Connectors	10	
太陽光発電システム用ジャンクションボックス / PV Junction Boxes	10	
スイッチ Switches	スイッチ / Switches	11
	検出スイッチ / Detector Switches	11
	ダブルアクションスイッチ / Double Action Switches	12
	カスタムデザインスイッチ / Custom Design Switches	12
タッチセンサ Touch Sensors	静電容量式タッチパネル / Capacitive Touch Panels	13
音響部品 Acoustic Components	マイクロホン / Microphones	14
	A ² B [®] マイクロホン / A ² B [®] Microphones	14
	MEMSマイクロホンユニット / MEMS Microphone Units	15
	エレクトレット コンデンサ マイクロホンユニット / Electret Condenser Microphone Units	16
	レシーバユニット / Receiver Units	17
	マイクロスピーカユニット / Micro Speaker Units	17
	イヤホンマイク / Earphone-Microphones	18
ヘッドホン・インナーイヤホン / Headphones , Inner Earphones	18	
無線関連製品 Wireless Connectivity Products	Bluetooth [®] モジュール / Bluetooth [®] Modules	19
	Bluetooth [®] 関連製品 / Bluetooth [®] Equipments	20
	無線関連製品 / Wireless Connectivity Products	21
リモコン Remote Control Units	リモコン / Remote Control Units	21
サーキットプロテクタ Circuit Protectors	サーキットプロテクタ / Circuit Protectors	21
DCソレノイド DC Solenoids	DCソレノイド / DC Solenoids	22
充電器 Chargers	ACアダプタ / AC Adaptors	22
	無接点充電器 / Wireless Charger	22

[用途 / Applications] 車載機器など / Automotive equipments, etc.

■HDMI Connectors Type E

外観 / Appearance	機種名 / Model No.	形式 / Type	定格 / Rating	接触抵抗 Contact Resistance	絶縁抵抗 Insulation Resistance	耐電圧 Withstanding Voltage	特性インピーダンス Characteristic Impedance
	TCX3407	Receptacle	0.5 A 40 V AC max.	10 mΩ max.	100 MΩ min. (at 500 V DC)	500 V AC / 1 minute	100 Ω ± 15 %
	TCX3407-11						
	TCX3467						
	TYX1666	Cable Assy E Plug to E Plug					
	TYX1667	Cable Assy E Plug to A Receptacle					
	TYX1694	Cable Assy E Plug to E Receptacle					



HDMI is a registered trademark or trademark of HDMI LICENSING L.L.C

USB Connectors

USB コネクタ

[用途 / Applications] スマートフォン、PC、車載機器など / Smart phones, PCs, Automotive equipments, etc.



■USB 2.0 Connectors

外観 / Appearance	機種名 / Model No.	形式 / Type		実装 / Mounting Style	定格 / Rating	接触抵抗 / Contact Resistance	備考 / Remarks
	TCS0112	Receptacle	Standard-A	DIP	2.4 A 5.25 V DC max.	100 mΩ max.	車載機器用 for Automotive
	TCS0113			SMT			

■USB 3.0 Connectors

カスタム生産のみ対応します。(以下の製品仕様は参考値です。)

We manufacture only custom production. (The following specifications are reference values.)

外観 / Appearance	機種名 / Model No.	形式 / Type		実装 / Mounting Style	定格 / Rating	接触抵抗 / Contact Resistance
	CMS1600	Receptacle	Standard-A	DIP	1.8 A 30 V AC max. (Power line)	30 mΩ max. (Power line)
	CMS1620		Standard-B		0.25 A 30 V AC max. (Signal line)	50 mΩ max. (Signal line)



■Micro-USB Connectors

カスタム生産のみ対応します。(以下の製品仕様は参考値です。)

We manufacture only custom production. (The following specifications are reference values.)

外観 / Appearance	機種名 / Model No.	形式 / Type		実装 / Mounting Style	定格 / Rating	接触抵抗 / Contact Resistance
	CMS1527	Receptacle	Micro-B	DIP (Contacts : SMT)	1 A 30 V AC max.	30 mΩ max.

■Mini-USB Connectors

外観 / Appearance	機種名 / Model No.	形式 / Type		実装 / Mounting Style	定格 / Rating	接触抵抗 / Contact Resistance
	TCS0101-11	Receptacle	Mini-B	SMT	1 A 30 V AC max.	50 mΩ max.
	TCS0102	Plug		—		

■Conversion Connectors

外観 / Appearance	機種名 / Model No.	形式 / Type
	HPC1591	USB-micro-B Socket to Type-C Plug

USB is a trademark of USB Implementers Forum.

DisplayPort™ Connectors

DisplayPort™ コネクタ

[用途 / Applications] テレビ、PC、プロジェクタなど / TVs, PCs, Projectors, etc.

■DisplayPort Connectors

外観 / Appearance	機種名 / Model No.	形式 / Type	定格 / Rating	接触抵抗 Contact Resistance	絶縁抵抗 Insulation Resistance	耐電圧 Withstanding Voltage	特性インピーダンス Characteristic Impedance
	TCX3250	Receptacle	0.5 A	30 mΩ max.	100 MΩ min. (at 500 V DC)	500 V AC / 1 minute	100 Ω ± 10 Ω (Tr=130ps (20%- 80%))
	TCX3251	Plug					
	TYX1603	Plug Cable					

DisplayPort™ is a registered trademark or trademark of Video Electronics Standards Association.

Slot-in type Connectors

スロットインタイプコネクタ

[用途 / Applications] 車載機器 / Automotive equipments

■Slot-in type Connectors

外観 / Appearance	機種名 / Model No.	インターフェイス / Interface	定格 / Rating	備考 / Remarks
	TCX3414	HDMI Type A Socket	0.5A 40V AC	HDMI Cable Assy
	TCX3232	USB2.0 Standard-A Socket	1A 30V AC 1A 5.25V DC	USB2.0 Cable Assy
	TCX3473	USB2.0 Standard-A Socket ×2 ports	2.4A 5.25V DC ×2 ports	USB2.0 Cable Assy
	TCX3474	USB2.0 Standard-A Socket ×2 ports	2.4A 5.25V DC ×2 ports	USB2.0 Cable Assy with illumination
	TCP9708	φ 3.5 Jack	0.5A 5V AC	Jack Cable Assy

FAKRA Connectors

FAKRA コネクタ

[用途 / Applications] 車載機器 / Automotive equipments

■FAKRA Connectors

外観 / Appearance	機種名 / Model No.	形式 / Type	定格 / Rating	接触抵抗 Contact Resistance	絶縁抵抗 Insulation Resistance	耐電圧 Withstanding Voltage	特性インピーダンス Characteristic Impedance	防水 Waterproof
	HPC1140	Receptacle	1A 60V DC	5 mΩ max.	1000 MΩ max.	500 V AC / 1 minute	50 Ω	—
	HPC1180							
	HPC1142	Plug	1A 60V DC					
	HPC1143	Socket						

Miniature Coaxial Connectors

小型同軸コネクタ

[用途 / Applications] 車載機器 / Automotive equipments

■Miniature Coaxial Connectors

外観 / Appearance	機種名 / Model No.	形式 / Type	定格 / Rating	接触抵抗 Contact Resistance	絶縁抵抗 Insulation Resistance	耐電圧 Withstanding Voltage	特性インピーダンス Characteristic Impedance	防水 Waterproof
	CMS1953	Receptacle	1A 14V DC	5 mΩ max.	1000 MΩ min.	500 V AC / 1 minute	50 Ω	—
	HPC1152	Plug	1A 60V DC					
	HPC1153	Socket						
	HPC1162	Plug						
	HPC1163	Socket						
								Waterproof

Connectors for Automotive Camera

車載カメラ用コネクタ

[用途 / Applications] 車載カメラ / Automotive Camera

■Connectors for Automotive Camera









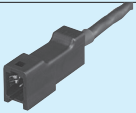

外観 / Appearance	機種名 / Model No.	形式 / Type	定格 / Rating	接触抵抗 Contact Resistance	絶縁抵抗 Insulation Resistance	耐電圧 Withstanding Voltage	特性インピーダンス Characteristic Impedance	防水 Waterproof
	CMS2200	Receptacle	1A 60V DC	15 mΩ max.	1000 MΩ min.	500 V AC / 1 minute	50 Ω	—
	CMS2300	—		5 mΩ max.				

High Speed Data Transfer Connectors(4Pin)

高速信号伝送コネクタ(4ピン)

[用途 / Applications] 車載機器 / Automotive equipments

■High Speed Data Transfer Connectors

外観 / Appearance	機種名 / Model No.	形式 / Type	定格 / Rating	接触抵抗 Contact Resistance	絶縁抵抗 Insulation Resistance	耐電圧 Withstanding Voltage	特性インピーダンス Characteristic Impedance
	CMS1900	Receptacle	2.1A 30V AC max.	30 mΩ max.	1000 MΩ min.	500V AC / 1 minute	100 Ω
	CMS1901						
	HPC1900	Plug					
	HPC1901	Socket					
	TCS7785	Receptacle	3A 12V DC max. (Powr Line) 1A 12V DC max. (Signal Line)	Pin-Contact 30 mΩ max. Plug Cover-socket 60 mΩ max.	100 MΩ min. (at 500 V DC)	500V AC / 1 minute	—
	TCS7799						
	TCS7790						
	TCP8986	Plug					
	TCP8987						
	TCP8992						
	TAS7016	Socket					

Micro-miniature Rectangular Connectors

角形マイクロミニチュアコネクタ

[用途 / Applications] ノートPC、デジタルカメラなど / Notebook PCs, DSCs, etc.

■Micro-miniature Rectangular Connectors

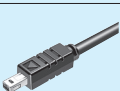
外観 / Appearance	機種名 / Model No.	形式 / Type	極数 Number of Contacts	定格 / Rating	接触抵抗 Contact Resistance	絶縁抵抗 Insulation Resistance	耐電圧 Withstanding Voltage
	TCX3171	Receptacle	8 P	0.5 A 5.25 V DC max. 1 A 30 V AC max.	60 mΩ max.	100 MΩ min. (at 500 V DC)	100 V AC / 1 minute
	TCX3166	Plug					

Rectangular Connectors

角形コネクタ

[用途 / Applications] OA機器、車載機器など / Office automation equipments, Automotive equipments, etc.

■Rectangular Connectors

外観 / Appearance	機種名 / Model No.	形式 / Type	極数 Number of Contacts	定格 / Rating	接触抵抗 Contact Resistance	絶縁抵抗 Insulation Resistance	耐電圧 Withstanding Voltage
	TCX3245	Receptacle	17 P	3 A 12 V DC max.	Pin-Contact 30 mΩ max. Plug Cover-Socket Cover 50 mΩ max.	50 MΩ min. (at 250 V DC)	250 V AC / 1 minute
	TCX3239	Plug					
	TCX3238	Socket					
	TCX3173	Receptacle	21 P	3 A 12 V DC max.	Pin-Contact 30 mΩ max. Plug Cover-Socket Cover 50 mΩ max.	50 MΩ min. (at 250 V DC)	250 V AC / 1 minute
	TCX3174	Plug					
	TCX3175	Socket					

Miniature Circular Connectors

丸形ミニチュアコネクタ

[用途 / Applications] OA機器、オーディオ機器など / Office automation equipments, Audio equipments, etc.

■Miniature Circular Connectors

外観 / Appearance	機種名 / Model No.	形式 / Type	極数 Number of Contacts	EMI	定格 / Rating	接触抵抗 Contact Resistance	絶縁抵抗 Insulation Resistance	耐電圧 Withstanding Voltage
	TCS7927-2□	Receptacle	4 P to 8 P	EMI-Proof	1 A 100 V AC max. 2 A 12 V DC max.	30 mΩ max.	50 MΩ min. (at 250 V DC)	250 V AC / 1 minute
	TCS7726		4 P to 6 P to 8 P					
	TCS7705	Receptacle	10 P					
	TCP8938	Plug						
	TCS7729	Receptacle	13 P					
	TCP8951	Plug						
	TCP8959							

Power Supply Connectors



電源用コネクタ

[用途／Applications] デジタルカメラ、タブレットPCなど／DSCs, Tablet PCs, etc.

カスタム生産のみ対応します。(以下の製品仕様は参考値です。)

We manufacture only custom production. (The following specifications are reference values.)

■Power Supply Connectors

外観／Appearance	機種名／Model No.	形式／Type	極数 Number of Contacts	定格／Rating	接触抵抗 Contact Resistance	絶縁抵抗 Insulation Resistance	耐電圧 Withstanding Voltage
	TCP7331	Receptacle	3 P	3 A 12 V DC max.	30 mΩ max.	100 MΩ min. (at 500 V DC)	500 V AC / 1 minute
	TCS7331-13	Plug					

AC Inlets

AC インレット

[用途／Applications] PC、オーディオ機器など／PCs, Audio equipments, etc.

カスタム生産のみ対応します。(以下の製品仕様は参考値です。)

We manufacture only custom production. (The following specifications are reference values.)

■AC Inlets

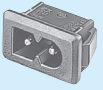
外観／Appearance	機種名／Model No.	定格／Rating	絶縁抵抗 Insulation Resistance	耐電圧 Withstanding Voltage	安全規格 Safety Standard
	HSC0573	2.5 A 250 V AC	100 MΩ min. (at 500 V DC)	4000 V AC / 1 minute	UL, CSA, VDE, SEMKO
	HSC0583				UL, CSA, VDE

Miniature Jacks



小形ジャック

[用途／Applications] スマートフォン、ポータブルオーディオなど／Smart phones, Portable audio players, etc.

カスタム生産のみ対応します。(以下の製品仕様は参考値です。)

We manufacture only custom production. (The following specifications are reference values.)

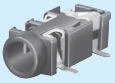
■Miniature Jacks

外観／Appearance	機種名／Model No.	形式／Type	極数 Number of Contacts	接触抵抗 Contact Resistance	絶縁抵抗 Insulation Resistance	耐電圧 Withstanding Voltage
	HSJ2636	φ 3.5	3 P	50 mΩ max.	100 MΩ min. (at 500 V DC)	500 V AC／1 minute
	HSJ2077	φ 3.5	3 P			

DC Power Jacks



DC電源ジャック

[用途／Applications] ノートPC、タブレットPCなど／Note PCs, Tablet PCs, etc.

カスタム生産のみ対応します。(以下の製品仕様は参考値です。)

We manufacture only custom production. (The following specifications are reference values.)

■DC power Jacks



外観／Appearance	機種名／Model No.	JEITA電圧区分／JEITA Voltage Classification	実装 Mounting Style	定格／Rating	絶縁抵抗 Insulation Resistance	耐電圧 Withstanding Voltage
	HEC3600	JEITA RC-5320A Voltage Classification 2	DIP	2 A 6.3 V DC	100 MΩ min. (at 500 V DC)	500 V AC／1 minute
	HEC3800	JEITA RC-5320A Voltage Classification 4	DIP	2 A 13.5 V DC		

PV Connectors

太陽光発電システム用コネクタ

[用途 / Applications] 太陽光発電モジュール / Photovoltaic Module

■PV Connectors

外観 / Appearance	機種名 / Model No.	形式 / Type	定格 / Rating	動作温度 / Operating Temperature	嵌合 / Mating		
					HSC2013	HSC2014	HSC2015
	HSC2014	Socket	30 A 1500 V DC max. (TÜV) 30 A 1500 V DC max. (UL)	- 40 °C to 90 °C (TÜV) - 40 °C to 85 °C (UL)	○		
	HSC2015				○		
	HSC2013	Plug				○	○

PV Junction Boxes

太陽光発電システム用ジャンクションボックス



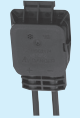
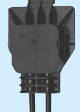

[用途 / Applications] 太陽光発電モジュール / Photovoltaic Module

■PV Junction Boxes

外観 / Appearance	機種名 / Model No.	形式 / Type	定格 / Rating	認証 / Certification	備考 / Remarks
	HSC2190	薄膜系用 / for Thin film module	5 A 1000V DC	TÜV / UL	ポットイング / Potting
	HSC2174		3 A 1000V DC		—
	HSC2413		3 A 1500V DC		—

[用途 / Applications] リモコン、デジタルカメラ、車載機器など / Remote control units, DSCs, Automotive equipments, etc.

Multi-Direction Switches

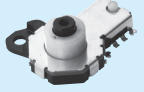
外観 / Appearance	機種名 / Model No.	形式 / Type	定格 / Rating	外形寸法 / Dimensions	動作力 / Operating Force	動作寿命 / Operating Life
	HXW0786	Shuttle push	10 mA 5 V DC max. 0.1 mA 1 V DC min.	9.5×9.25×1.65 mm	0.65±0.3 N Push Switch 2±1 N	100,000 cycles
	HXW1723 (custom product)	Multi direction	10 mA 5 V DC	17.5×17.5×7.6 mm	4-Direction 3.6±1.0 N Center 7.2±1.0 N	100,000 cycles 15,000 cycles (Jog)
	HXW0805-31 (custom product)	Multi direction	10 mA 5 V DC max. 1 mA 1 V DC min.	13.7×14.3×5.8 mm	4-Direction 2±0.5 N Center 4.5±1 N	1,000,000 cycles
	HXW0805-01 (custom product)	Multi direction	10 mA 5 V DC max. 1 mA 1 V DC min.	13.7×14.3×5.8 mm	8-Direction 2±0.5 N Center 4.5±1 N	1,000,000 cycles
	HAW0910	Rotary	10 mA 5 V DC max. 1 mA 1 V DC min.	17×11×2.8 mm	13±3.5 mN·m	100,000 cycles

Detector Switches

検出スイッチ

[用途 / Applications] 産業機器など / Industrial equipments, etc.

Detector Switches



外観 / Appearance	機種名 / Model No.	形式 / Type	定格 / Rating	接触抵抗 Contact Resistance	絶縁抵抗 Insulation Resistance	耐電圧 Withstanding Voltage
	HAW0962	Detector	2 mA 3.6 V DC max. 0.1 mA 1.8 V DC min.	50 mΩ max.	100 MΩ min. (at 500 V DC)	500 V AC / 1 second

Double Action Switches

ダブルアクションスイッチ

[用途 / Applications] 携帯電話、デジタルカメラなど / Mobile phones, DSCs, etc.

■ Double Action Switches

外観 / Appearance	機種名 / Model No.	形式 / Type	定格 / Rating	外形寸法 / Dimensions	動作力 / Operating Force	動作寿命 / Operating Life
	HKW0731	Right angle	50 mA 5 V DC	5.1×3.2×1.2 mm	1st click 0.7 N 2nd click 2.0 N	100,000 cycles
	HKW0773	Vertical	50 mA 5 V DC	4.4×3.2×0.6 mm	1st click 0.7 N 2nd click 2.0 N	100,000 cycles
	HKW0820	Vertical Long Stroke	50 mA 5 V DC	7.0×6.1×1.3 mm	1st click 0.7 N 2nd click 2.0 N	200,000 cycles

Custom Design Switches

カスタムデザインスイッチ

[用途 / Applications] 車載機器、デジタルカメラ、ガスコンロなど / Automotive equipments, DSCs, Gas cookers, etc.

お客様のご要望に合わせ、設計から製造までお引き受けいたします。
We design and manufacture products based on customers' request.



HKW1598※



HKW1918※



HUW4125※



HUW1261※



HPW0369※

ガスコンロ用スイッチ
Switch for Gass cooker

スイッチユニット / Switch Units



HXW2711※
(Seatbelt Switch)



HXW2800※
(Seatbelt Switch)



HXW2022※
(Seatbelt Switch)

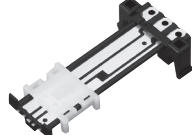

HMW0380※
(Seatbelt Switch)

車載用スイッチ
Switches for Automotive

Capacitive Touch Panels

静電容量式タッチパネル



[用途／Applications] カーナビゲーション、タブレットPCなど／Car Navigations, Tablet PCs, etc.

カスタム生産のみ対応します。(以下の製品仕様は参考値です。)

We manufacture only custom production. (The following specifications are reference values.)

■ Capacitive Touch Panels

外観／Appearance	動作温度 Operation temperature	透過率 Rate of transparent	反射率 Rate of reflection
	- 30 °C to 85 °C	80 % min.	7.5 % max.

外観／Appearance	形式／Type	構成／Constitution	備考／Remarks
	樹脂カバータイプ Plastic Cover Type	樹脂カバーパネル (厚さ 1 ~ 3mm) ／光学接着／ガラスセンサ Plastic cover panel (thickness 1 to 3mm) ／Optical bonding ／Glass sensor	樹脂カバーパネル表面への AG、AR、AFP 処理可能 AG or AR or AFP can be processed into plastic cover panel surface
	曲面 (2.5D) タイプ Single Axis Curved Type	1 方向曲げ樹脂カバーパネル (1000R) ／光学接着／フィルムセンサ Curved plastic cover panel in one axis direction (1000R) ／Optical bonding ／Film sensor	
	OGS タイプ One Glass Solution Type	カバーガラス一体型 Cover glass integrated	

* タッチパネルやカバーガラスとLCDの貼合せ加工等も対応します。

We also have optical bonding process for pasting a LCD, a touch panel, a cover glass and so on together.

Microphones

マイクロホン

[用途 / Applications] 車載機器、AV機器など / Automotive equipments, Audio visual equipments, etc.

Microphones

外観 / Appearance	機種名 / Model No.	マイクロホンユニット / Microphone Unit	指向性 / Directivity	感度 Sensitivity (at 1 kHz)	SN比 SN Ratio (typ)	最大入力音圧 Maximum Input S.P.L. (at 1 kHz)
	KHM0016	ECM	単一指向性 Uni directional	- 43.5 dBV / Pa	60 dB	100 dB SPL (THD 1 %)
	KHM8962	ECM	単一指向性 Uni directional	- 40 dBV / Pa	60 dB	100 dB SPL (THD 1 %)
	KHM0071	ECM	単一指向性 Uni directional	- 43 dBV / Pa	60 dB	100 dB SPL (THD 1 %)

A²B[®] Microphones

A²B[®] マイクロホン

[用途 / Applications] 車載機器 / Automotive equipments

A²B[®] Microphones

外観 / Appearance	機種名 / Model No.	形式 / Type	指向性 / Directivity	感度 Sensitivity (dB / Pa)	SN比 SN Ratio	最大入力音圧 Maximum Input S.P.L.	備考 Remarks
	HHM1005	Digital	全指向性 Omni directional	-34 ± 2.5 dBFS (at 1kHz, 0dB=1 V / Pa)	60 dB min (at 94 dB SPL, 1kHz, A-weight)	126 dB SPL THD Max 10% at 1kHz	A ² B [®] (Automotive Audio Bus Dual Type)
	HHM1015	Digital	全指向性 Omni directional	-34 ± 2.5 dBFS (at 1kHz, 0dB=1 V / Pa)	60 dB min (at 94 dB SPL, 1kHz, A-weight)	126 dB SPL THD Max 10% at 1kHz	A ² B [®] (Automotive Audio Bus Single Type)
	HHM1016	Digital	全指向性 Omni directional	-34 ± 2.5 dBFS (at 1kHz, 0dB=1 V / Pa)	60 dB min (at 94 dB SPL, 1kHz, A-weight)	126 dB SPL THD Max 10% at 1kHz	A ² B [®] (Automotive Audio Bus Single Type)

A²B[®] is registered trademark or trademark of Analog Devices, Inc.

MEMS Microphone Units

MEMSマイクロホンユニット

[用途 / Applications] スマートフォン、携帯電話など / Smart phones, Mobile phones, etc.

MEMS Microphone Units (Omni-Directional)

外観 / Appearance	機種 Model No.	形式 Type	感度 Sensitivity (at 1 kHz)	SN比 SN Ratio (typ)	電源 Power Supply	消費電流 Current Consumption (max.)	外形寸法 Dimensions	特長 Features
	KRM0300	Analog Top Port	- 42 dB (V / Pa)	59 dB	2 V DC	0.2 mA	3.76 × 2.95 × 1.1mm	—
			- 42 dB (V / Pa)	62 dB	2 V DC	0.2 mA	3.76 × 2.95 × 1.1mm	Low THD Active Noise Cancellation
	KRM5200	Analog Bottom Port	- 38 dB (V / Pa)	63 dB	2 V DC	0.2 mA	3.76 × 2.95 × 1.1mm	—
			- 38 dB (V / Pa)	62 dB	2.75 V DC	0.2 mA	3.76 × 2.95 × 1.1mm	Low THD
	KRM5400	Analog Bottom Port	- 38 dB (V / Pa)	70 dB	2.5 V DC	0.25 mA	4.0 × 3.0 × 1.2mm	High SNR Low THD
	KRM5600		- 38 dB (V / Pa)	67 dB	2.5 V DC	0.25 mA	3.5 × 2.65 × 0.98mm	High SNR Low THD
	KRM5700		- 38 dB (V / Pa)	65 dB	2 V DC	0.2 mA	2.75 × 1.85 × 0.9mm	—
			- 38 dB (V / Pa)	61 dB	2.75 V DC	0.2 mA	2.75 × 1.85 × 0.9mm	Low THD
	KRM5610		- 38 dB (V / Pa)	67.5 dB	2.5 V DC	0.25 mA	3.5 × 2.65 × 1.5mm	High SNR Low THD Active Noise Cancellation
	KRM5303		- 46 dB (FS / Pa)	63 dB	1.8 V DC	1.6 mA	4.0 × 3.0 × 1.0mm	Low THD
	KRM5403		- 36 dB (FS / Pa)	69 dB	1.8 V DC	1.2 mA	4.0 × 3.0 × 1.2mm	High SNR
	KRM5603		- 34 dB (FS / Pa)	65 dB	1.8 V DC	0.8 mA	3.5 × 2.65 × 0.98mm	—
	KRM5613	- 34 dB (FS / Pa)	65 dB	1.8 V DC	0.9 mA	3.5 × 2.65 × 1.5mm	Active Noise Cancellation	

Electret Condenser Microphone Units
エレクトレットコンデンサマイクロホンユニット
[用途 / Applications] スマートフォン、携帯電話など / Smart phones, Mobile phones, etc.

■Electret Condenser Microphone Units

外観 / Appearance	機種 / Model No.	形式 / Type	指向性 Directivity	感度 Sensitivity (at 1 kHz)	SN比 SN Ratio (typ)	電源 Power Supply	消費電流 Current Consumption (max.)	外形寸法 / Dimensions	
	KUC3523	Foil Electret	Omni	- 45 dB (V / Pa)	60dB	4.5 V DC	0.8 mA	ø 9.4×4.5 mm	
	KUC4023		Omni	- 45 dB (V / Pa)	60dB	4.5 V DC	0.8 mA	ø 9.7×6.7 mm	
	KUB2823	Back Electret	Omni	- 45 dB (V / Pa)	57dB	2 V DC	0.5 mA	ø 6.0×2.7 mm	
	KUB4223		Omni	- 34 dB (V / Pa)	67dB	3 V DC	0.6 mA	ø 6.0×1.9 mm	
	KUB4225		Omni	- 43 dB (V / Pa)	67dB	2 V DC	0.2 mA	ø 6.0×1.9 mm	
	KUB0623		Omni	- 42 dB (V / Pa)	60dB	2 V DC	0.5 mA	ø 4.0×1.3 mm	
	KUB0625		Omni	- 45 dB (V / Pa)	65dB	2 V DC	0.2 mA	ø 4.0×1.3 mm	
	KUB8923		Uni	- 40 dB (V / Pa)	62dB	4.5 V DC	0.5 mA	ø 9.4×4.7 mm	
	KUB8223		Uni	- 45 dB (V / Pa)	60dB	4.5 V DC	0.5 mA	ø 8.0×4.5 mm	
	KUB9023		Uni	- 45 dB (V / Pa)	57dB	2 V DC	0.5 mA	ø 6.0×2.2 mm	
	KUS0623		Reflow type	Omni	- 44 dB (V / Pa)	57dB	2 V DC	0.5 mA	ø 4.0×1.3 mm

Receiver Units

レシーバユニット

[用途 / Applications] スマートフォン、携帯電話など / Smart phones, Mobile phones, etc.

Receiver Units

外観 / Appearance	機種名 / Model No.	定格 Rated Input (back volume)	インピーダンス Impedance (at 2kHz)	出力音圧 S.P.L. *1 (Rated input/ 0.05m/at 2kHz)	最低共振周波数 Resonance Frequency (back volume)	外形寸法 Dimensions	防水性能 (保護等級) Waterproof	備考 / Remarks
	HDR2260-014180	20 mW(3cc)	27 Ω	76.5 dB	400 Hz(Free)	6×15×2 mm	IPX5 IPX8	3GPP wide band Hearing aid
	HDR2260-014170	20 mW(Free)	27 Ω	76.5 dB	730 Hz(Free)	6×15×2.2 mm	IPX5 IPX8	High F0 type
	HDR2259-014170	18.8 mW(Free)	30 Ω	74 dB	500 Hz(Free)	6×12×2 mm	IPX5 IPX8	—
	HDR2270-014050	20 mW(Free)	27.5 Ω	74.5 dB	500 Hz(Free)	6×12×1.5 mm	IPX5 IPX8	Thinnest type

*1 measured method = Baffle board 50mm / with rated back volume

Micro Speaker Units

マイクロスピーカユニット

[用途 / Applications] スマートフォン、携帯電話など / Smart phones, Mobile phones, etc.

Micro Speaker Units

外観 / Appearance	機種名 / Model No.	定格 Rated Input (back volume)	インピーダンス Impedance	出力音圧 S.P.L. (back volume)	最低共振周波数 Resonance Frequency (back volume)	外形寸法 / Dimensions	備考 / Remarks
	HDR9269	0.5 W (20cc)	8 Ω	89.5 dB (20cc) 1 W / 1 m at 2kHz	1230 Hz (20cc)	8×16×3 mm	防水性能 (保護等級) Waterproof IPX5 IPX8
	HDR9270	0.7 W (5cc)	8 Ω	71.5 dB (5cc) 1 W / 1 m at 2kHz	590 Hz (5cc)	9×16×3.0 mm	防水性能 (保護等級) Waterproof IPX5 IPX8
	HDR9271	0.5 W (1cc)	8 Ω	70 dB (1cc) 1 W / 1 m at 2kHz	800 Hz (1cc)	8×15×2.5 mm	防水性能 (保護等級) Waterproof IPX5 IPX8
	HDR9407	0.3 W (20cc)	8 Ω	74 dB (20cc) 1 W / 1 m at 2kHz	760 Hz (20cc)	∅ 16×3.2 mm	—
	HDR9432	0.32 W (Free)	43 Ω	78.5 dB (Free) 0.32 W / 1 m at 1kHz	870 Hz (Free)	∅ 37×17 mm	車載用 for Automotive
	HDR9440	1 W (Free)	8 Ω	86 dB (Free) 1 W / 1 m at 1kHz	780 Hz (Free)	with Baffle ∅48×11.5mm (unit: ∅40×8 mm)	車載用 for Automotive

Earphone - Microphones

イヤホンマイク

[用途／Applications] スマートフォン、携帯電話など／Smart phones, Mobile phones, etc.

お客様のご要望に合わせ、設計から製造までお引き受けいたします。
We design and manufacture products based on customers' request.

■Earphone-Microphones

外観／Appearance	機種名／Model No.	レシーバ／Receiver				マイクロホン／Microphone	
		形式／Type	定格入力 Rated Input	インピーダンス Impedance	出力音圧 S.P.L. (at 1KHz)	インピーダンス Impedance	感度 Sensitivity
	HBH0210	Dynamic	1 mW	32Ω	102 dB/mW	2.2 kΩ	- 44.5 dB/pa

Headphones & Inner Earphones

ヘッドホン・インナーイヤホン





[用途／Applications] スマートフォン、ポータブルオーディオなど／Smart phones, Portable audio players, etc.

お客様のご要望に合わせ、設計から製造までお引き受けいたします。
We design and manufacture products based on customers' request.

■Headphones

外観／Appearance	機種名／Model No.	形式／Type	定格入力 Rated Input	出力音圧 S.P.L. (at 1KHz)	備考／Remarks
	HDH0297	Dynamic	1 mW	108 dB	ハイレゾリューション・オーディオ対応 リケーブル対応 High-Resolution Audio correspondence Recable correspondence

■Inner Earphones



外観／Appearance	機種名／Model No.	形式／Type	定格入力 Rated Input	インピーダンス Impedance	出力音圧 S.P.L. (at 1KHz)	備考／Remarks
	HDH0298	Dynamic	1 mW	32 Ω	104 dB/mW	ハイレゾリューション・オーディオ対応 ハウジング:樹脂タイプ High-Resolution Audio correspondence Housing:Resin type
	HDH0299					ハイレゾリューション・オーディオ対応 ハウジング:金属(アルミニウム)タイプ High-Resolution Audio correspondence Housing: Metal (aluminum) type
	HDH0302					ハイレゾリューション・オーディオ対応 ハウジング:金属(真鍮)タイプ High-Resolution Audio Correspondence Housing: Metal(brass) type
	HDH0303					ハイレゾリューション・オーディオ対応 MMCXコネクタ対応 High-Resolution Audio Correspondence MMCX Connector Correspondence

Bluetooth® Modules

Bluetooth® モジュール

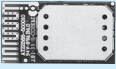

[用途 / Applications] PC、スマートフォンなど / PCs, Smart phones, etc.

■Bluetooth® Modules

外観 / Appearance	機種名 / Model No.	インターフェイス Interface	Bluetooth Version	QDID	無線出力電力 RF Output Power	外形寸法 Dimensions	電源電圧 Supply Voltage	内蔵メモリー Internal Memory	使用チップ System on Chip
	HRM1016	UART / USB / GPIO / AIO / I ² S / Analog Audio	4.1 (Dual Mode)	90835 (Component)	+4 dBm typ. (class1)	12.7×23.0×2.6 mm typ.	2.5 V to 4.25 V	16 MB Flash	CSR8670
	HRM1086	UART / USB / GPIO / AIO / I ² S / SPI / I ² C / Analog Audio	5.0 (Dual Mode)	—	—	12.7×23.0×2.25 mm typ.	2.8 V to 4.6 V	128 MB Flash	Qualcomm QCC5125

[用途 / Applications] リモコン、ヘルスケア機器など / Remote control units, Health care devices, etc.

■Bluetooth® Low Energy Modules

外観 / Appearance	機種名 / Model No.	インターフェイス Interface	Bluetooth Version	QDID	無線出力電力 RF Output Power	外形寸法 Dimensions	電源電圧 Supply Voltage	内蔵メモリー Internal Memory	使用チップ System on Chip
	HRM1017	UART / SPI / I ² C / GPIO / AIO	4.1 (Single Mode)	70482	-20 to +4 dBm (Programmable range)	12.7×23.0×2.6 mm typ.	1.8 V to 3.6 V	256 kB Flash	nRF51822 (QFN)
	HRM1026	UART / SPI / I ² C / GPIO / AIO	4.1 (Single Mode)	70459	-20 to +4 dBm (Programmable range)	9.0×15.5×1.9 mm typ.	1.8 V to 3.6 V	256 kB Flash	nRF51822 (WLCSP)
	HRM1062	UART / SPI / I ² C / GPIO / ADC / NFC / PDM	5.0 (Single Mode)	—	-40 to +4 dBm (Programmable range)	13.5×22.0×2.7 mm typ.	1.7 V to 3.6 V	512 kB Flash	nRF52832 (QFN)
	HRM1079	UART / SPI / I ² C / GPIO / ADC / NFC / PDM	5.0 (Single Mode)	119069	-40 to +4 dBm (Programmable range)	9.0×15.5×1.9 mm typ.	1.7 V to 3.6 V	512 kB Flash	nRF52832 (WLCSP)
	HRM3012	UART / SPI / I ² C / GPIO / ADC / I ² S	5.0 (Single Mode)	—	-21 to +5 dBm (Programmable range)	12.5×20.0×2.9 mm typ.	1.8 V to 3.6 V	352 kB Flash	CC2642R CC2642 (Automotive grade)



Bluetooth® is registered trademarks owned by Bluetooth SIG, Inc. and any use of such marks by HOSIDEN is under licence.

Bluetooth® Equipments

Bluetooth® 関連製品

[用途 / Applications] ポータブルオーディオなど / Portable audio players, etc.

■Bluetooth® Speaker with Microphone

外観 / Appearance	機種名 / Model No.	Bluetooth Version	QDID	対応プロファイル Supported Profile	無線出力電力 RF Output Power	外形寸法 Dimensions
	HBG5006	2.1+EDR	19467	HSP, HFP, A2DP, AVRCP	3 dBm typ. (class1)	123×38.5×36.8 mm typ.
	HBG5011					120×84.5×17.8 mm typ.

[用途 / Applications] スマートフォン連動情報配信、位置検知 / Information Service and Position detection

■Bluetooth® Low Energy Beacons

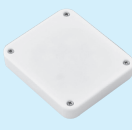
外観 / Appearance	機種名 / Model No.	Bluetooth Version	QDID	電源電圧 / Supply Voltage	無線出力電力 / RF Output Power	寸法 / Dimensions	電源 / Power Supply	防水性能 (保護等級) Waterproof
	HRM5011	4.1 (Single Mode)	70482	1.8 V to 3.6 V, 3.0 V typ.	-20 to +4 dBm (Programmable range)	φ 50.0 x t17 mm typ.	CR2450 × 1	—
	HRM5026	4.1 (Single Mode)	70482	1.8 V to 3.6 V, 3.0 V typ.	-20 to +4 dBm (Programmable range)	80.0 x 92.0 x 16.2 mm typ.	CR2477 × 3	IPX4

IR Headphones

IR ヘッドホン

[用途 / Applications] カーオーディオ(リアシートエンターテインメント)など / Car Audio (Rear seat entertainment), etc.



HRH0616

■IR Headphones

機種名 / Model No.	HRH0616
受信方式 / Receiving System	赤外線方式周波数変調 / Infrared Frequency Modulation
受信周波数 / Receiving Frequency	Ach Lch 2.3MHz ± 30kHz Ach Rch 2.8MHz ± 30kHz optional(Bch Lch 3.2MHz ± 30kHz Bch Rch 3.8MHz ± 30kHz)
電源電圧 / Supply Voltage	2.4 V to 3.4 V
信号対雑音比 / Signal to Noise Ratio	50dB min.
バッテリー寿命 / Battery Life	20h min.
オートパワーオフ機能 / Auto Power off	3min 45sec ± 15sec (No Modulation Signal) 4h ± 15 min (Audio Streaming)
電源 / Power Supply	AAA battery × 2

Remote Control Units

リモコン

[用途 / Applications] AV機器、住設機器(照明、エアコン等)、車載機器など / Audio visual equipments, Housing equipments (Lighting, air conditioners, etc.), Automotive equipments, etc.

お客様のご要望に合わせ、設計から製造までお引き受けいたします。
We design and manufacture products based on customers' request.



HTR1008



ETR0088



HTR1045 ※

Circuit Protectors

サーキットプロテクタ

[用途 / Applications] 自動販売機、電動工具など / Vending machines, Motor-driven tools, etc.

■Circuit Protectors

外観 / Appearance	機種名 / Model No.	定格電圧 / Rated Voltage	定格電流 / Rated Current	リセット形式 / Reset Formula	安全規格 / Safety Standard
	TBC5000	125 V AC 250 V AC	1, 1.25, 1.6, 2, 2.5, 3.15, 3.5, 4, 5, 6.3, 8, 10, 12, 15	Manual Auto	CSA, VDE
	TBC6000	125 V AC 250 V AC	0.63, 0.8, 1, 1.25, 1.6, 2, 2.5, 3.15, 4, 5	Manual	CSA, VDE, DEMKO

DC Solenoids



DCソレノイド

[用途 / Applications] 車載機器、自動販売機など / Car electronics, Vending machines, etc.

カスタム生産のみ対応します。(以下の製品仕様は参考値です。)

We manufacture only custom production. (The following specifications are reference values.)

■DC Solenoids



外観 / Appearance	機種名 / Model No.	入力電力 / Input Power	ストローク / Stroke	吸引力 / Attraction Force	外形寸法 / Dimensions
	JPM1316	5.2 W	3 mm	0.74 N	12.0 × 9.5 × 21.0 mm
	JSM5034	12.5 W	2 mm	2.94 N (Holding Force 3.92 N)	16.0 × 14.0 × 26.5 mm

AC Adaptors

ACアダプタ

[用途 / Applications] スマートフォン、携帯電話など / Smart phones, Mobile phones, etc.

■AC Adaptors

外観 / Appearance	機種名 / Model No.	定格入力 / Rated Input	定格出力 / Rated Output	特長 / Features
	CBC2078	100 V to 240 V AC (50Hz / 60Hz)	1 A 5 V DC	USBソケット出力 / USB socket output
	CBC2120	100 V to 240 V AC (50Hz / 60Hz)	1.8 A 5.0 V DC 1.8 A 9.0 V DC 1.35 A 12.0 V DC	QuickCharge2.0 Class A準拠 / High-power AC adaptor compliant with QuickCharge2.0 Class A.
	CBC2153	100 V to 240 V AC (50Hz / 60Hz)	3.0 A 5.0 V DC 3.0 A 7.0 V DC 3.0 A 9.0 V DC 2.25 A 12.0 V DC	USB Power Delivery 2.0対応 Compliant with USB Power Delivery 2.0 USB Type-Cプラグ出力 USB Type-C plug output

Wireless Charger

無接点充電器

[用途 / Applications] スマートフォン、車載機器など / Smart phones, Automotive equipments, etc.

お客様のご要望に合わせ、車載機器および民生機器用途に設計から製造までお引受けします。

We design and manufacture products based for automotive equipments and consumer equipments on customers' request.

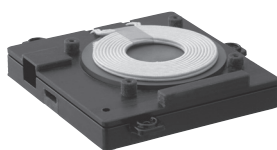

Qi ワイヤレスチャージャー (送電モジュール)
Qi wireless charger (power transfer module)

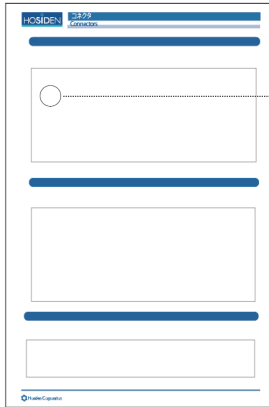

※印製品は、お客様のオーダーによりホシデンが設計から製造、メンテナンスまで一貫してお届けした例です。（お客様のご厚意により掲載させていただきました）
このように、ホシデンはお客様のご要望にも積極的に対応いたします。お気軽にご相談ください。

※Means products of custom designed, built and maintained by HOSIDEN .(Exhibited with thanks to customers)
HOSIDEN is ready to respond to customer needs.
Please feel free to contact with us.

ホシデン株式会社

<https://www.hosiden.co.jp>

本社

〒581-0071 大阪府八尾市北久宝寺1-4-33
Tel : 072-993-1010 Fax : 072-994-5101

大阪営業部

〒581-0071 大阪府八尾市北久宝寺1-4-33
Tel : 072-924-8922 Fax : 072-994-8506

東京営業部

〒221-0014 横浜市神奈川区入江1-14-25
Tel : 045-423-2263 Fax : 045-423-2209

海外営業部

〒581-0071 大阪府八尾市北久宝寺1-4-33
Tel : 072-924-8930 Fax : 072-924-8937

北関東営業所

〒321-0953 栃木県宇都宮市東宿郷1-9-15 (フローラビル 9F)
Tel : 028-666-8407 Fax : 028-666-8409

名古屋営業部

〒465-0024 名古屋市名東区一社2-6 (サニーヴェイル社301)
Tel : 052-704-3300 Fax : 052-704-3323

広島営業所

〒730-0043 広島市中区富士見町16-22 ロアール富士見町 6F 603号室
Tel : 082-545-3536 Fax : 082-541-1237

株式会社 サトレックス

本社

〒537-0025 大阪市東成区中道3-15-16 (毎日東ビル3F)
Tel : 06-6974-3303 Fax : 06-6974-3305

東京営業所

〒221-0014 横浜市神奈川区入江1-14-25 (ホシデン東京社社内)
Tel : 045-423-6066 Fax : 045-423-6067

Hosiden Corporation

<https://www.hosiden.com>

Head Office

4-33, Kitakyuhoji 1-chome, Yao-city, Osaka 581-0071, Japan
Phone : +81-72-993-1010 Fax : +81-72-994-5101

Japan

Overseas Division :

4-33, Kitakyuhoji 1-chome, Yao-city, Osaka 581-0071, Japan
Phone : +81-72-993-1010 Fax : +81-72-924-8937

China

Hosiden Electronics(Shanghai) Co., Ltd.

Room 802, Kirin Plaza, No.666 Gu Bei Road, Changning District, Shanghai P.R.China
Phone : +86-21-5208-1488 Fax : +86-21-5208-1480

Hosiden (Shenzhen) Co., Ltd.

Room2716, Changping Commercial Building, 99 Honghua Road,
Futian Free Trade Zone, Shenzhen, China
Phone : +86-755-8348-0952 Fax : +86-755-8359-7722

Hong Kong

Hong Kong Hosiden Ltd.

Units 09A(01), 2/F., Laurels Industrial Centre, 32 Tai Yau Street San Po Kong, Kowloon, Hong Kong
Phone : +852-23238181 Fax : +852-23520425

Taiwan

Taiwan Hosiden Co., Ltd.

3F., No.34, Sec. 3, Zhongshan N. Rd., Zhongshan Dist., Taipei City 10452, Taiwan
Phone : +886-2-2503-5611 Fax : +886-2-2517-8573

Singapore

Hosiden Singapore Pte. Ltd.

28, Genting, Lane, #05-01, Platinum 28, Singapore 349585
Phone : +65-6296-8100 Fax : +65-6296-8200

Malaysia

Hosiden Electronics(Malaysia)Sdn. Bhd

Lot 1, Jalan P/1A, Bangi Industrial Estate 43650 Bandar Baru Bangi, Selangor Darul Ehsan, Malaysia
Phone : +60-3-89258622 Fax : +60-3-89258620

Thailand

Hosiden (Thailand) Co., Ltd.

43 Thai CC Tower 16st Fl., Room 163, South Sathorn Rd., Kwaeng Yannawa,
Khet Sathorn, Bangkok 10120, Thailand
Phone : +66-2-673-9760, 9761 Fax : +66-2-673-9762

Germany

Hosiden Europe GmbH

Graf-Recke-Straße 82, 40239 Düsseldorf, Germany
Phone : +49-211-96493-0 Fax : +49-211-96493-90

Frankfurt Office

Ohmstrasse 53, Frankfurt am Main 60486 Germany
Phone : +49-69-7103-5170

U.K.

Hosiden Besson Ltd.

12 St. Joseph's Trading Estate St. Joseph's Close, Hove, East Sussex,
BN3 7EZ, United Kingdom
Phone : +44-1273-860000 Fax : +44-1273-777501

U.S.A.

Hosiden America Corp.

Head Office

120 East State Parkway, Schaumburg, IL, 60173, U.S.A.
Phone : +1-847-885-8870 Fax : +1-847-885-0063

San Jose Sales Office

1245 South Winchester Blvd., Suite 306, San Jose, CA 95128, U.S.A.
Phone : +1-408-985-8780 Fax : +1-408-985-8785

Detroit Sales Office

39575 Lewis Drive, Suite #900, Novi, MI. 48377, U.S.A.
Phone : +1-248-489-0174 Fax : +1-248-489-1154

- ・製品の改良などにより、当カタログの記載内容を予告無く変更する場合があります。また、当カタログに掲載された製品は予告なく製造中止することがあります。
- ・当カタログの掲載製品は全て RoHS 指令に適合しています。
- ・The contents described in this catalog may be changed without prior notice due to products improvements or discontinuance of production.
- ・Every product in this catalog is compliant to RoHS directive.

⚠ 安全に関するご注意

ご使用の際は、納入仕様書を確認の上、正しくお使いください。

⚠ CAUTION FOR SAFETY

Please use our products properly based on our Drawing and Specification.

(日本語) URL: <https://www.hosiden.co.jp>

(English) URL: <https://www.hosiden.com>

Printed in Japan September 2019

Catalog No. PG2020 (TP) . 3500 ㊤