

A2B Microphone Unit For HF&ANC HHM1016

Overview

- A2B (automotive audio bus) interface compatible
- 125-dB SPL high sound-pressure input microphone
- Signal to noise ratio: 65 dB (typ.)
- Flat low-frequency characteristics
- For HF & ANC Application

Block Diagram

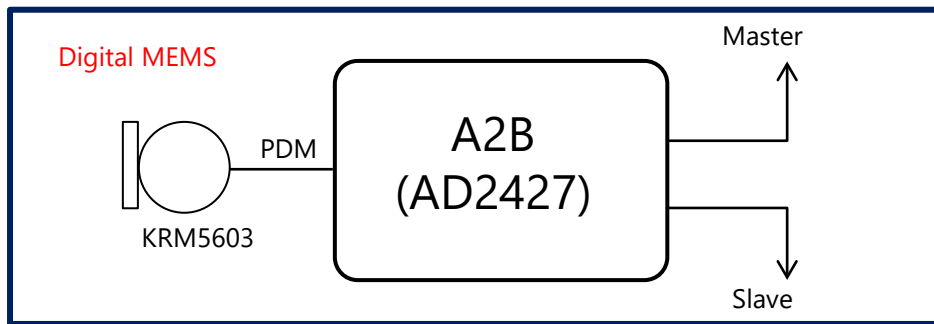

Frequency Response

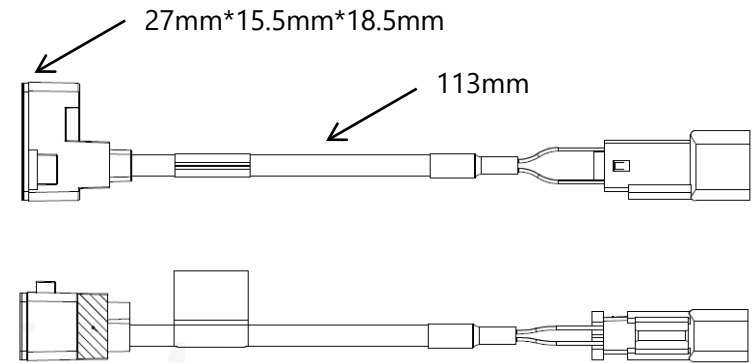
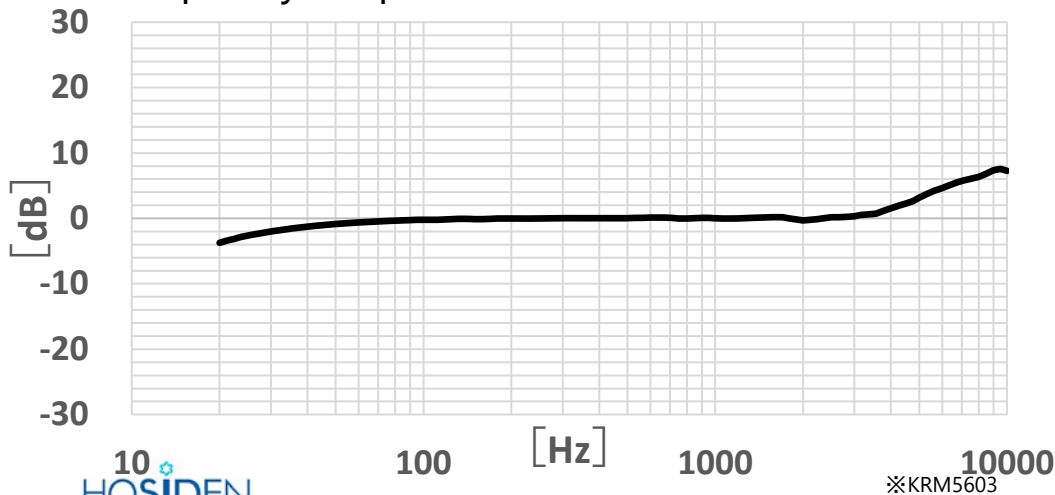

Specifications

Item	Specification
Operation Temperature Range	-40°C ~ +85°C
Maximum Input Level	125dB SPL (THD 10% TYP at 1kHz)
SN Ratio	65dB (TYP)
Sensitivity	-34±2.5 dBFS/Pa at 1kHz
Connector	12047786 (Delphi)